

Safety features explained

Magnet LED-indicator

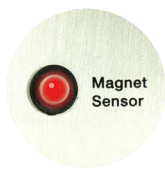

The control panel on your magnetic drilling machine is designed for maximum ease of use and safety. Here you can find the magnet LED-indicator. There are two options:

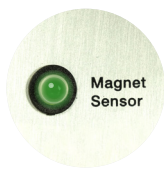

SENSORTEC

The LED-indicator lights up **GREEN** when the generated magnetic force is sufficient. You can now safely start your drilling job.

The LED-indicator lights up **RED** when the generated magnetic force is insufficient due to:

- Surface not being flat
- Workpiece not being magnetisable (e.g. aluminium)
- Workpiece is coated or painted
- Workpiece is not thick enough

If resolving the above doesn't help, the magnet doesn't function properly. Don't start your drilling job, but have your machine checked and serviced.

Gyro-Tec safety



Gyro-Tec safety features a gyroscopic sensor which detects acceleration and displacement in any direction. The **Gyro-Tec** safety feature engages three seconds after the motor is started. Whenever the machine recognises a sudden or unwanted movement the motor will be shut down automatically by the machine's electronics. This safety functionality offers extra protection in various circumstances, such as:

- Sudden loss of magnetic force while in operation
- Excessive vibration caused by incorrect drilling procedure, worn-out cutting tools, etc.
- Sudden displacement of the workpiece to which the magnetic drilling machine is attached

By the motor shutting down automatically, risk of damaging or hurting the machine, tools, workpiece and operator is reduced.

Integrated motor cable

The frame of your magnetic drilling machine is designed for maximum safety and comfort. It is provided with an ergonomic handle and part of the machines in our portfolio have an integrated motor cable. The machines with integrated cable offer increased safety as the cable is completely incorporated in the frame. This prevents the user from getting caught in the cable and the cable from tearing or snapping off. It also prevents a lot of unnecessary repairs and therefore additional costs because the user can no longer lift and carry the machine by the motor cable, which often happens in practice.



2-way magnet



The 2-way magnet saves energy when the machine is not being used. The machine sticks sufficiently at half the magnetic force, this ensures you use less energy. The magnet generates less heat which makes the lifespan of the machine is longer. Only with full magnetic force the machine can be used for drilling.

Power protection

The power protection feature is two-fold; it consists of both power fluctuation protection and power surge protection. Special safety components built into the electronics of the machine make it more reliable in situations where power supply can be of varying quality due to factors:

- Around the workplace, for example caused by switching on high power or unreliable electrical devices, a broken circuit breaker or faulty wiring
- Outside the workplace, for example caused by an instable power grid or lightning

A machine with this feature is able to cope with standard rated voltage and frequency fluctuations ranging from:

- 110 Volt to 130 Volt and 45 Hz to 65 Hz, or
- 220 Volt to 240 Volt and 45 Hz to 65 Hz reducing the probability of breakdown and minimizing down-time and repair cost.

Power fluctuation protection



When the frequency is too high (above 65 Hz) or too low (below 45 Hz), the motor will not start. If the frequency of the power supply falls outside the range during your drilling job, the motor will shut off automatically. The machine will work again normally when the normal frequency has been restored.*

Power surge protection



Beyond the rated voltage, a machine with this feature is able to cope with voltage spikes up to 4,000 Volt (1-2 μ s)*, which could be caused by nearby welding activities. Depending on the height of the spike, it may be necessary to replace built-in fuses, the control unit or the power switch, but other valuable parts like the motor and magnet will be protected.

Overload protection



To ensure safe use and longer lifetime of the motor the machine profits by overload protection. While you are using the machine there are different types of load levels, which correlate with the feed pressure. Once you go from close to overload to exceeding the overload limit the machine will automatically stop the motor.

Smart Restart



When the motor is in overload, the **Smart Restart** torque control technology ensures trouble-free continuation of your drilling job. When the feed pressure is reduced, the machine's electronics recognise the reduction and the motor continues within a few seconds.

Overheat protection



To prevent damage, machines with this feature are equipped with a sensor which will shut off the motor automatically when the temperature of the field coil exceeds 100° C - 105° C.

*Disclaimer: Euroboor is not liable for any damage caused to the machine due to electrical problems in the workplace. Above mentioned protection is not guaranteed in all cases of voltage spikes and/or frequency fluctuations. Euroboor accepts no liability when it comes to the power protection not functioning or functioning poorly.



Carbon brushes

The carbon brushes on the magnetic drilling machine are equipped with two protective features. The purpose of both features is to schedule timely service and avoid additional costs by unexpected downtime or unnecessary part replacement.

Carbon brush wear indicator



On the motor housing you will find an integrated LED light. Under normal circumstances this light is off. The LED light will start burning **RED** when the carbon brushes are worn to a level where it is advised to replace them.

Automatic shut-off



When the carbon brushes are actually worn to a level where replacement is needed, the motor will be shut-off automatically. This prevents the armature from being damaged. Once shut off, the LED-indicator is no longer lit.

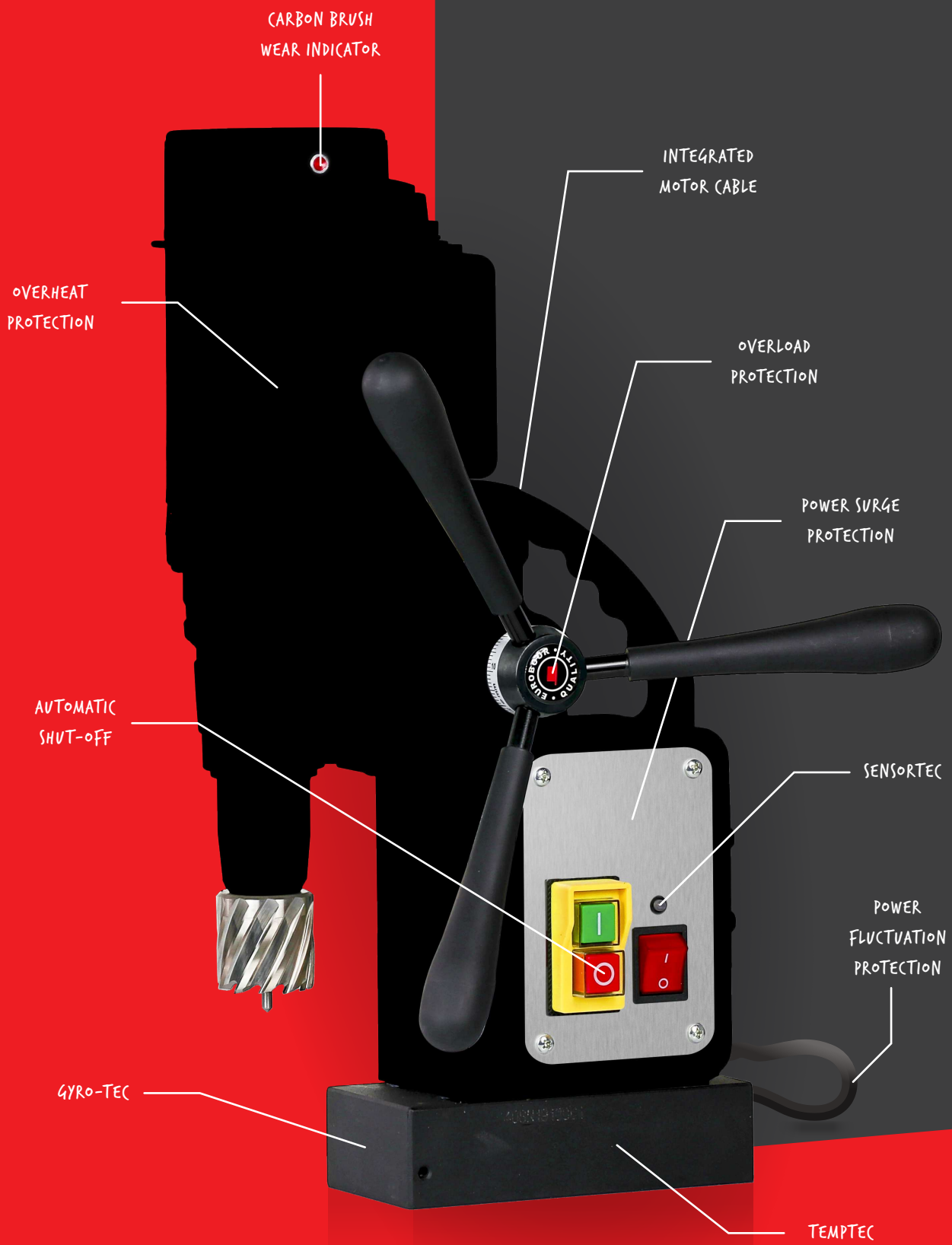

ECO.30



Watch our machines in action on:
www.youtube.com/euroboorbv



Technical data

Annular cutting	Ø 12 - 30 mm
Twist drilling (Weldon)	Ø 1 - 13 mm
Countersinking (Weldon)	Ø 10 - 35 mm
Length	275 mm
Width	190 mm
Height	293 - 383 mm
Stroke	90 mm
Weight*	8.5 kg
Magnet (l x w x h)	160 x 80 x 37 mm
Magnetic force	1,200 kg
Motor power	900 W
Total power	950 W
Speed (no load)	I 775 rpm
Speed (load 900 W)	I 400 rpm
Spindle (Weldon)	19.05 mm (3/4")
Voltage	110 - 120 V / 60 Hz
	220 - 240 V / 50 - 60 Hz

*Exclusive power cord and handles



Benefits

- Lightest Ø 30 mm magnetic drilling machine:
 - Most compact in class
 - Incredibly easy to handle
- Direct spindle drive and integrated tool cooling and lubrication
- One-speed gearbox
- Integrated slide for:
 - High accuracy
 - Enlarged lifecycle
 - Minimal vibration
- High-precision height adjustment for:
 - Low maintenance
 - Minimal wear correction
- Strong dual coil CNC machined 2-way magnet, causing the machine to use less energy, generate less heat and therefore lasts longer
- Reversible handles: to enable you to change the operation side of the feed handles in confined spaces
- Also available with permanent TUBE magnet for both pipe and flat material (page. 40)

**Lightest Ø 30 mm
magnetic drilling
machine in the market**

Features



2-way
magnet
(TempTec)



8.5
weight

ECO.30S+



Watch our machines in action on:
www.youtube.com/euroboorbv



Technical data

Annular cutting	Ø 12 - 30 mm
Twist drilling (Weldon)	Ø 1 - 13 mm
Countersinking (Weldon)	Ø 10 - 35 mm
Length	275 mm
Width	190 mm
Height	293 - 383 mm
Stroke	90 mm
Weight*	8.5 kg
Magnet (l x w x h)	160 x 80 x 37 mm
Magnetic force	1,200 kg
Motor power	900 W
Total power	950 W
Speed (no load)	I 775 rpm
Speed (load 900 W)	I 400 rpm
Spindle (Weldon)	19.05 mm (3/4")
Voltage	110 - 120 V / 60 Hz
	220 - 240 V / 50 - 60 Hz

*Exclusive power cord and handles

Benefits

- Lightest Ø 30 mm magnetic drilling machine:
 - Most compact in class
 - Incredibly easy to handle
- Direct spindle drive and integrated tool cooling and lubrication
- Integrated slide for:
 - High accuracy
 - Enlarged lifecycle
 - Minimal vibration
- High-precision height adjustment for:
 - Low maintenance
 - Minimal wear correction
- Strong dual coil CNC machined 2-way magnet, causing the machine to use less energy, generate less heat and therefore lasts longer
- Reversible handles: to enable you to change the operation side of the feed handles in confined spaces
- Reduced risk of damaging machine, tools and workpiece and hurting operator
- Suitable for use in areas and workplaces where power supply is of less quality
- Reduced risk of armature damage
- Reduced risk of control unit(s) damage
- Timely service notification to avoid additional cost by unexpected downtime or unnecessary part replacement

CARBON BRUSH WEAR INDICATOR



AUTOMATIC SHUT-OFF

POWER SURGE PROTECTION

POWER FLUCTUATION PROTECTION

GYRO-TEC

TEMPTEC

Features



Power surge protection



Power fluctuation protection



Gyro-Tec



Automatic shut-off



Oil lubricated gearbox



Carbon brush wear indicator



2-way magnet (TempTec)



8.5 weight

Optimised motor efficiency and lifetime of key components due to oil lubricated gearbox



ECO.32



Watch our machines in action on:
www.youtube.com/euroboorbv



Technical data

Annular cutting	Ø 12 - 32 mm
Twist drilling	Ø 1 - 13 mm
Countersinking	Ø 10 - 40 mm
Length	320 mm
Width	210 mm
Height	370 - 512 mm
Stroke	150 mm
Weight*	11 kg
Magnet (l x w x h)	160 x 80 x 42 mm
Magnetic force	1,500 kg
Motor power	1,000 W
Total power	1,050 W
Speed (no load)	I 775 rpm
Speed (load 1,000 W)	I 440 rpm
Spindle (Weldon)	19.05 mm (3/4")
Voltage	110 - 120 V / 60 Hz
	220 - 240 V / 50 - 60 Hz

*Exclusive power cord and handles



Benefits

- One-speed gearbox
- Detachable spindle drive and integrated tool cooling and lubrication
- Integrated slide for:
 - High accuracy
 - Enlarged lifecycle
 - Minimal vibration
- High-precision height adjustment for:
 - Low maintenance
 - Minimal wear correction
- Strong dual coil CNC machined 2-way magnet, causing the machine to use less energy, generate less heat and therefore lasts longer

Features



Magnet
LED-indicator
(SensorTec)



2-way
magnet
(TempTec)

ECO.32+



Watch our machines in action on:
www.youtube.com/euroboorbv



Technical data

Annular cutting	Ø 12 - 32 mm
Twist drilling	Ø 1 - 13 mm
Countersinking	Ø 10 - 40 mm
Length	320 mm
Width	210 mm
Height	370 - 512 mm
Stroke	150 mm
Weight*	11 kg
Magnet (l x w x h)	160 x 80 x 42 mm
Magnetic force	1,500 kg
Motor power	1,000 W
Total power	1,050 W
Speed (no load)	I 775 rpm
Speed (load 1,000 W)	I 440 rpm
Spindle (Weldon)	19.05 mm (3/4")
Voltage	110 - 120 V / 60 Hz
	220 - 240 V / 50 - 60 Hz

*Exclusive power cord and handles

Benefits

- One-speed gearbox
- Detachable spindle drive and integrated tool cooling and lubrication
- Integrated slide for:
 - High accuracy
 - Enlarged lifecycle
 - Minimal vibration
- High-precision height adjustment for:
 - Low maintenance
 - Minimal wear correction
- Strong dual coil CNC machined 2-way magnet, causing the machine to use less energy, generate less heat and therefore lasts longer
- Reduced risk of damaging machine, tools and workpiece and hurting operator
- Suitable for use in areas and workplaces where power supply is of less quality
- Reduced risk of armature damage
- Reduced risk of control unit(s) damage
- Timely service notification to avoid additional cost by unexpected downtime or unnecessary part replacement

CARBON BRUSH
WEAR INDICATOR



Features



Power surge protection



Power fluctuation protection



Gyro-Tec



Automatic shut-off



Carbon brush wear indicator



2-way magnet (TempTec)



Magnet LED-indicator (SensorTec)

ECO.32-T



Watch our machines in action on:
www.youtube.com/euroboorbv



Technical data

Annular cutting	Ø 12 - 32 mm
Twist drilling	Ø 1 - 13 mm
Countersinking	Ø 10 - 40 mm
Tapping	M3 - M12
Length	320 mm
Width	210 mm
Height	370 - 512 mm
Stroke	150 mm
Weight*	11 kg
Magnet (l x w x h)	160 x 80 x 42 mm
Magnetic force	1,500 kg
Motor power	1,000 W
Total power	1,050 W
Speed (no load)	I 150 - 600 rpm
Speed (load 1,000 W)	I 225 rpm
Spindle (Weldon)	19.05 mm (3/4")
Voltage	110 - 120 V / 60 Hz
	220 - 240 V / 50 - 60 Hz

*Exclusive power cord and handles



Benefits

- One-speed gearbox
- Detachable spindle drive and integrated tool cooling and lubrication
- Integrated slide for:
 - High accuracy
 - Enlarged lifecycle
 - Minimal vibration
- High-precision height adjustment for:
 - Low maintenance
 - Minimal wear correction
- Strong dual coil CNC machined 2-way magnet, causing the machine to use less energy, generate less heat and therefore lasts longer

Features



Adjustable speed



R/L rotation



Magnet LED-indicator (SensorTec)



2-way magnet (TempTec)



Tapping

ECO.40/2+



Watch our machines in action on:
www.youtube.com/euroboorbv



Technical data

Annular cutting	Ø 12 - 40 mm
Twist drilling	Ø 1 - 13 mm
Countersinking	Ø 10 - 45 mm
Length	320 mm
Width	210 mm
Height	395 - 540 mm
Stroke	150 mm
Weight*	11.5 kg
Magnet (l x w x h)	160 x 80 x 42 mm
Magnetic force	1,500 kg
Motor power	1,050 W
Total power	1,100 W
Speed (no load)	I 720 rpm
	II 1,300 rpm
Speed (load 1,050 W)	I 315 rpm
	II 560 rpm
Spindle (Weldon)	19.05 mm (3/4")
Voltage	110 - 120 V / 60 Hz
	220 - 240 V / 50 - 60 Hz

*Exclusive power cord and handles

Benefits

- Particularly suitable for both annular cutting and twist drilling
- Detachable spindle drive and integrated tool cooling and lubrication
- Two-speed gearbox
- Integrated slide for:
 - High accuracy
 - Enlarged lifecycle
 - Minimal vibration
- High-precision height adjustment for:
 - Low maintenance
 - Minimal wear correction
- Strong dual coil CNC machined 2-way magnet causing the machine to use less energy, generate less heat and therefore lasts longer
- Reduced risk of damaging machine, tools and workpiece and hurting operator
- Suitable for use in areas and workplaces where power supply is of less quality
- Reduced risk of armature damage
- Reduced risk of control unit(s) damage
- Timely service notification to avoid additional cost by unexpected downtime or unnecessary part replacement



Shown extras not included.

Features



Power surge protection



Power fluctuation protection



Gyro-Tec



Automatic shut-off



Carbon brush wear indicator



Magnet LED-indicator (SensorTec)



2-way magnet (TempTec)

ECO.40S



Watch our machines in action on:
www.youtube.com/euroboorbv



Technical data

Annular cutting	Ø 12 - 40 mm
Twist drilling	Ø 1 - 16 mm
Countersinking	Ø 10 - 45 mm
Length	264 mm
Width	180 mm
Height	360 - 440 mm
Stroke	145 mm
Weight*	10.5 kg
Magnet (l x w x h)	160 x 80 x 42 mm
Magnetic force	1,500 kg
Motor power	1,150 W
Total power	1,200 W
Speed (no load)	I 600 rpm
Speed (load 1,150 W)	I 380 rpm
Spindle (Weldon)	19.05 mm (3/4")
Voltage	110 - 120 V / 60 Hz
	220 - 240 V / 50 - 60 Hz

*Exclusive power cord and handles



Benefits

- Lightest Ø 40 mm magnetic drilling machine
- Fits cutters up to 110 mm DoC
- High-efficiency motor with less heat generation
- High-accuracy capstan hub
- Direct spindle drive and integrated tool cooling and lubrication
- Integrated slide for:
 - High accuracy
 - Enlarged lifecycle
 - Minimal vibration
- High-precision height adjustment for:
 - Low maintenance
 - Minimal wear correction
- Strong dual coil CNC machined 2-way magnet causing the machine to use less energy, generate less heat and therefore lasts longer
- Reversible handles: to enable you to change the operation side of the feed handles in confined spaces

**Lightest Ø 40 mm
magnetic drilling
machine in the market**

Features



Oil lubricated
gearbox



Magnet
LED-indicator
(SensorTec)



2-way
magnet
(TempTec)

Optimised motor efficiency and lifetime of
key components due to oil lubricated gearbox



ECO.40S+



Watch our machines in action on:
www.youtube.com/euroboorbv



Technical data

Annular cutting	Ø 12 - 40 mm
Twist drilling	Ø 1 - 16 mm
Countersinking	Ø 10 - 45 mm
Length	264 mm
Width	180 mm
Height	360 - 440 mm
Stroke	145 mm
Weight*	10.5 kg
Magnet (l x w x h)	160 x 80 x 42 mm
Magnetic force	1,500 kg
Motor power	1,150 W
Total power	1,200 W
Speed (no load)	I 600 rpm
Speed (load 1,150 W)	I 380 rpm
Spindle (Weldon)	19.05 mm (3/4")
Voltage	110 - 120 V / 60 Hz
	220 - 240 V / 50 - 60 Hz

*Exclusive power cord and handles

Benefits

- Lightest Ø 40 mm magnetic drilling machine
- Fits cutters up to 110 mm DoC
- High-efficiency motor with less heat generation
- High-accuracy capstan hub
- Direct spindle drive and integrated tool cooling and lubrication
- Integrated slide for:
 - High accuracy
 - Enlarged lifecycle
 - Minimal vibration
- High-precision height adjustment for:
 - Low maintenance
 - Minimal wear correction
- Strong dual coil CNC machined 2-way magnet, causing the machine to use less energy, generate less heat and therefore lasts longer
- Reduced risk of damaging machine, tools and workpiece and hurting operator
- Suitable for use in areas and workplaces where power supply is of less quality
- Reduced risk of armature damage
- Reduced risk of control unit(s) damage
- Timely service notification to avoid additional cost by unexpected downtime or unnecessary part replacement
- Reversible handles: to enable you to change the operation side of the feed handles in confined spaces

Features



Power surge protection



Power fluctuation protection



Gyro-Tec



Integrated motor cable



Automatic shut-off



Oil lubricated gearbox



Carbon brush wear indicator



2-way magnet (TempTec)



Magnet LED-indicator (SensorTec)

Optimised motor efficiency and lifetime of key components due to oil lubricated gearbox



SAFETY FIRST



ECO.40S+/P



Watch our machines in action on:
www.youtube.com/euroboorbv



Technical data

Annular cutting	Ø 12 - 40 mm
Twist drilling	Ø 1 - 16 mm
Countersinking	Ø 10 - 45 mm
Length	264 mm
Width	180 mm
Height	360 - 440 mm
Stroke	145 mm
Weight*	10.5 kg
Magnet (l x w x h)	160 x 80 x 42 mm
Magnetic force	1,500 kg
Motor power	1,150 W
Total power	1,200 W
Speed (no load)	I 600 rpm
Speed (load 1,150 W)	I 380 rpm
Spindle (Weldon)	19.05 mm (3/4")
Voltage	110 - 120 V / 60 Hz
	220 - 240 V / 50 - 60 Hz

*Exclusive power cord and handles



Benefits

- Safest Ø 40 mm magnetic drilling machine
- Fits cutters up to 110 mm DoC
- High-efficiency motor with less heat generation
- High-accuracy capstan hub
- Direct spindle drive and integrated tool cooling and lubrication
- Integrated slide for:
 - High accuracy
 - Enlarged lifecycle
 - Minimal vibration
- High-precision height adjustment for:
 - Low maintenance
 - Minimal wear correction
- Reduced risk of damaging machine, tools and workpiece and hurting operator
- Suitable for use in areas and workplaces where power supply is of less quality
- Reduced risk of armature damage
- Reduced risk of control unit(s) damage
- Timely service notification to avoid additional cost by unexpected downtime or unnecessary part replacement
- Reversible handles: to enable you to change the operation side of the feed handles in confined spaces

Magnet benefits

- Permanent, non-electric monobloc magnet system
- No loss of magnetic grip in case of electric power cuts or fluctuations
- Powerful hold, even on thinner steel

Features



Power surge protection



Power fluctuation protection



Gyro-Tec



Integrated motor cable



Automatic shut-off



Oil lubricated gearbox



Carbon brush wear indicator



Permanent magnet



Magnet LED-indicator (SensorTec)

Optimised motor efficiency and lifetime of key components due to oil lubricated gearbox



ECO.50-T



Watch our machines in action on:
www.youtube.com/euroboorbv



Technical data

Annular cutting	Ø 12 - 50 mm
Twist drilling	Ø 1 - 23 mm
Countersinking	Ø 10 - 55 mm
Tapping	M3 - M20
Length	320 mm
Width	210 mm
Height	385 - 540 mm
Stroke	170 mm
Weight*	13.5 kg
Magnet (l x w x h)	170 x 85 x 48 mm
Magnetic force	1,850 kg
Motor power	1,250 W
Total power	1,375 W
Speed (no load)	I 100 - 280 rpm
	II 185 - 530 rpm
Speed (load 1,250 W)	I 250 rpm
	II 460 rpm
Spindle (Weldon)	MT2 19.05 mm (3/4")
Voltage	110 - 120 V / 60 Hz
	220 - 240 V / 50 - 60 Hz

*Exclusive power cord and handles



Benefits

- Morse Taper 2 spindle with integrated tool cooling and lubrication
- Two-speed gearbox
- Integrated slide for:
 - High accuracy
 - Enlarged lifecycle
 - Minimal vibration
- High-precision height adjustment for:
 - Low maintenance
 - Minimal wear correction
- Strong dual coil CNC machined 2-way magnet causing the machine to use less energy, generate less heat and therefore lasts longer

Features



Adjustable speed



R/L rotation



Overload protection



Overheat protection



Smart Restart



Magnet LED-indicator (SensorTec)



2-way magnet (TempTec)



Tapping

ECO.50+ / T



Watch our machines in action on:
www.youtube.com/euroboorbv



Technical data

Annular cutting	Ø 12 - 50 mm
Twist drilling	Ø 1 - 23 mm
Countersinking	Ø 10 - 55 mm
Tapping	M3 - M20
Length	320 mm
Width	210 mm
Height	385 - 540 mm
Stroke	170 mm
Weight*	13.5 kg
Magnet (l x w x h)	170 x 85 x 48 mm
Magnetic force	1,850 kg
Motor power	1,250 W
Total power	1,375 W
Speed (no load)	I 100 - 280 rpm
	II 185 - 530 rpm
Speed (load 1,250 W)	I 250 rpm
	II 460 rpm
Spindle (Weldon)	MT2 19.05 mm (3/4")
Voltage	110 - 120 V / 60 Hz
	220 - 240 V / 50 - 60 Hz

*Exclusive power cord and handles



Benefits

- Morse Taper 2 spindle with integrated tool cooling and lubrication
- Two-speed gearbox
- Integrated slide for:
 - High accuracy
 - Enlarged lifecycle
 - Minimal vibration
- High-precision height adjustment for:
 - Low maintenance
 - Minimal wear correction
- Strong dual coil CNC machined 2-way magnet causing the machine to use less energy, generate less heat and therefore lasts longer
- Reduced risk of damaging machine, tools and workpiece and hurting operator
- Suitable for use in areas and workplaces where power supply is of less quality
- Reduced risk of armature damage
- Reduced risk of control unit(s) damage
- Timely service notification to avoid additional cost by unexpected downtime or unnecessary part replacement

Features



Adjustable speed



R/L rotation



Overload protection



Overheat protection



Power surge protection



Power fluctuation protection



Gyro-Tec



Automatic shut-off



Smart Restart



Carbon brush wear indicator



Magnet LED-indicator (SensorTec)



2-way magnet (TempTec)



Tapping

ECO.50S



Watch our machines in action on:
www.youtube.com/euroboorbv



Technical data

Annular cutting	Ø 12 - 50 mm
Twist drilling	Ø 1 - 23 mm
Countersinking	Ø 10 - 55 mm
Length	320 mm
Width	200 mm
Height	445 - 615 mm
Stroke	170 mm
Weight*	12 kg
Magnet (l x w x h)	168 x 84 x 42 mm
Magnetic force	1,700 kg
Motor power	1,250 W
Total power	1,300 W
Speed (no load)	I 380 rpm
	II 690 rpm
Speed (load 1,250 W)	I 235 rpm
	II 415 rpm
Spindle (Weldon)	MT3 19.05 mm (3/4")
Voltage	110 - 120 V / 60 Hz
	220 - 240 V / 50 - 60 Hz

*Exclusive power cord and handles



Benefits

- High-accuracy capstan hub
- Morse Taper 3 spindle with integrated tool cooling and lubrication
- Integrated slide for:
 - High accuracy
 - Enlarged lifecycle
 - Minimal vibration
- High-precision height adjustment for:
 - Low maintenance
 - Minimal wear correction
- Strong dual coil CNC machined magnet

Features



Oil lubricated
gearbox



2-way
magnet
(TempTec)



Magnet
LED-indicator
(SensorTec)

Optimised motor efficiency and lifetime of
key components due to oil lubricated gearbox



ECO.50S+



Watch our machines in action on:
www.youtube.com/euroboorbv



Technical data

Annular cutting	Ø 12 - 50 mm
Twist drilling	Ø 1 - 23 mm
Countersinking	Ø 10 - 55 mm
Length	320 mm
Width	200 mm
Height	445 - 615 mm
Stroke	170 mm
Weight*	12 kg
Magnet (l x w x h)	168 x 84 x 42 mm
Magnetic force	1,700 kg
Motor power	1,250 W
Total power	1,300 W
Speed (no load)	I 380 rpm
	II 690 rpm
Speed (load 1,250 W)	I 235 rpm
	II 415 rpm
Spindle (Weldon)	MT3 19.05 mm (3/4")
Voltage	110 - 120 V / 60 Hz
	220 - 240 V / 50 - 60 Hz

*Exclusive power cord and handles

Benefits

- High-accuracy capstan hub
- Morse Taper 3 spindle with integrated tool cooling and lubrication
- Integrated slide for:
 - High accuracy
 - Enlarged lifecycle
 - Minimal vibration
- High-precision height adjustment for:
 - Low maintenance
 - Minimal wear correction
- Strong dual coil CNC machined 2-way magnet, causing the machine to use less energy, generate less heat and therefore lasts longer
- Reduced risk of damaging machine, tools and workpiece and hurting operator
- Suitable for use in areas and workplaces where power supply is of less quality
- Reduced risk of armature damage
- Reduced risk of control unit(s) damage
- Timely service notification to avoid additional cost by unexpected downtime or unnecessary part replacement

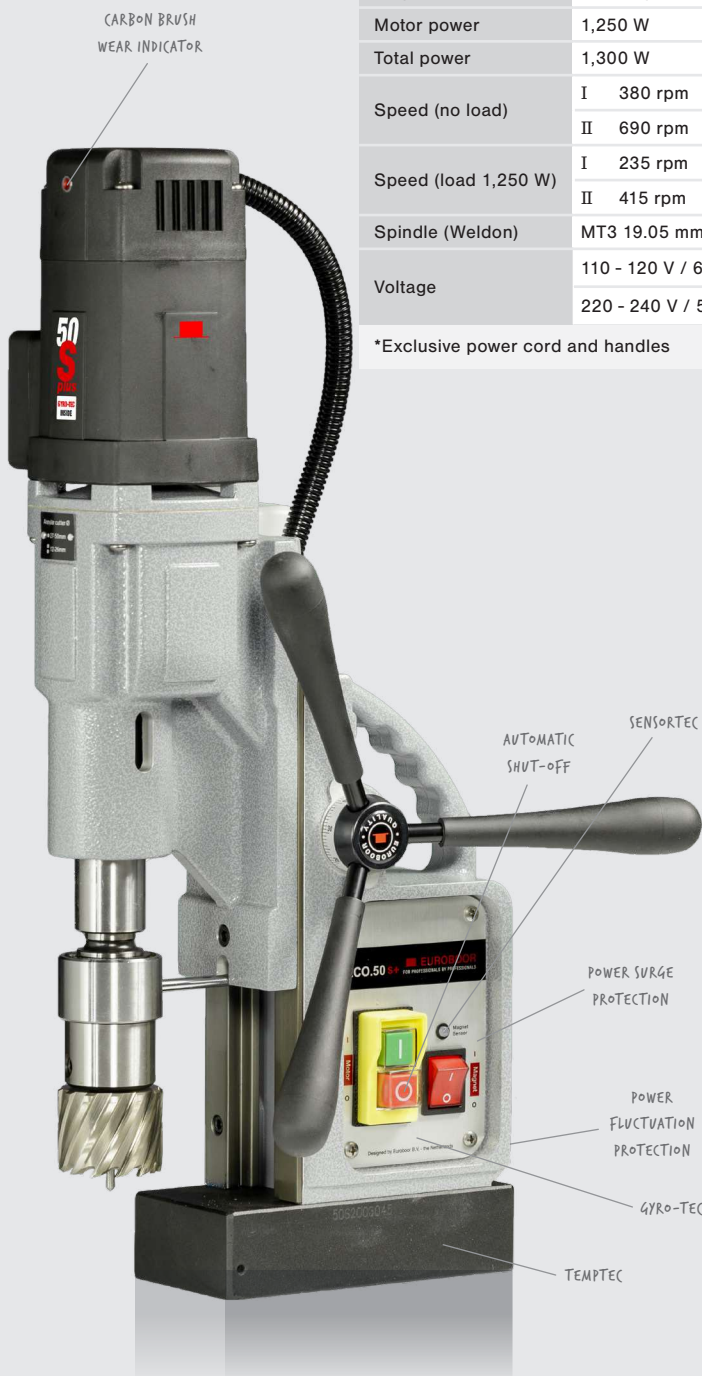

Features



Power surge protection



Power fluctuation protection



Gyro-Tec



Automatic shut-off



Oil lubricated gearbox



Carbon brush wear indicator



2-way magnet (TempTec)



Magnet LED-indicator (SensorTec)

Optimised motor efficiency and lifetime of key components due to oil lubricated gearbox





Drilling as efficiently as you possibly can!

Euroboor's magnetic drilling machines that truly match your level of professionalism. There is no doubt your needs for fully assisted and fastest drilling with the highest accuracy are being met by our **ECO.55s+T** and **ECO.55s+TA**



Top features

LED load indicators and digital display with Smart Restart technology

Easily accessible carbon brushes
When replacement is needed the motor will be shut-off automatically

Oil lubricated gearbox
Maximum lubrication

Integrated slide and gearbox system
- High accuracy
- Sturdy design enlarges lifecycle
- Minimal vibration

Automatic drill functionality with automatic return on the ECO.55S+/TA
(Only for annular cutting)

Z-profile guide rails
Maximum contact surface

Clear and easy controls
With RPM dial and right/left rotation functionality



LED load indicators

- | | |
|---|---|
| ● ● ● ● | ● ● ● ● |
| 1. Machine is on.
No load. | 2. Start drilling.
Ideal working load. |
| ● ● ● ● | ● ● ● ● |
| 3. When drilling.
Acceptable overload. | 4. Close to overload.
Reduce pressure. |

* Smart Restart

When the motor is in overload, the Smart Restart torque control technology () ensures trouble-free continuation of your drilling job. When the feed pressure is reduced, the machine's electronics recognises the reduction and the motor continues. This benefits your drilling process, saves time and prevents excessive tool wear and failure.

 A flashing red light with beeping sound means the overload limit is exceeded. The motor halts.*

ECO.55S+/T



Watch our machines in action on:
www.youtube.com/euroboorbv



Technical data

Annular cutting	Ø 12 - 55 mm
Twist drilling	Ø 1 - 23 mm
Countersinking	Ø 10 - 60 mm
Tapping	M3 - M20
Length	320 mm
Width	200 mm
Height	490 - 660 mm
Stroke	170 mm
Weight*	12.9 kg
Magnet (l x w x h)	168 x 84 x 49 mm
Magnetic force	1,850 kg
Motor power	1,600 W
Total power	1,700 W
Speed (no load)	I 60 - 275 rpm
	II 100 - 500 rpm
Speed (load 1,600 W)	I 60 - 275 rpm
	II 100 - 500 rpm
Spindle (Weldon)	MT3 19.05 mm (3/4")
Voltage	110 - 120 V / 60 Hz
	220 - 240 V / 50 - 60 Hz

*Exclusive power cord and handles



Benefits

- Easily accessible carbon brushes. Motor will automatically shut-off in case of replacement
- High-accuracy capstan hub
- Morse Taper 3 spindle with integrated tool cooling and lubrication
- Integrated slide for:
 - High accuracy
 - Enlarged lifecycle
 - Minimal vibration
- High-precision height adjustment for:
 - Low maintenance
 - Minimal wear correction
- Strong dual coil CNC machined 2-way magnet causing the machine to use less energy, generate less heat and therefore lasts longer
- Reduced risk of damaging machine, tools and workpiece and hurting operator
- Suitable for use in areas and workplaces where power supply is of less quality
- Reduced risk of armature damage
- Reduced risk of control unit(s) damage
- Timely service notification to avoid additional cost by unexpected downtime or unnecessary part replacement
- Also available with permanent TUBE magnet for both pipe and flat material (page. 41)

Features



Adjustable speed



R/L rotation



Overload protection



Overheat protection



Power surge protection



Power fluctuation protection



Gyro-Tec



Automatic shut-off



Smart Restart



Oil lubricated gearbox



Digital display



Carbon brush wear indicator



LED load indicators



2-way magnet (TempTec)



Magnet LED-indicator (SensorTec)



Tapping

Optimised motor efficiency and lifetime of key components due to oil lubricated gearbox



ECO.55S+/TA



Watch our machines in action on:
www.youtube.com/euroboorbv



Technical data

Annular cutting	Ø 12 - 55 mm
Twist drilling	Ø 1 - 23 mm
Countersinking	Ø 10 - 60 mm
Tapping	M3 - M20
Length	345 mm
Width	305 mm
Height	490 - 660 mm
Stroke	170 mm
Weight*	15.8 kg
Magnet (l x w x h)	168 x 84 x 49 mm
Magnetic force	1,850 kg
Motor power	1,600 W
Total power	1,700 W
Speed (no load)	I 60 - 275 rpm
	II 100 - 500 rpm
Speed (load 1,600 W)	I 60 - 275 rpm
	II 100 - 500 rpm
Spindle (Weldon)	MT3 19.05 mm (3/4")
Voltage	110 - 120 V / 60 Hz
	220 - 240 V / 50 - 60 Hz

*Exclusive power cord and handles

CARBON BRUSH
WEAR INDICATOR

OVERHEAT
PROTECTION



Benefits

- Easily accessible carbon brushes. Motor will automatically shut-off in case of replacement
- High-accuracy capstan hub
- Morse Taper 3 spindle with integrated tool cooling and lubrication
- Integrated slide for:
 - High accuracy
 - Enlarged lifecycle
 - Minimal vibration
- High-precision height adjustment for:
 - Low maintenance
 - Minimal wear correction
- Strong dual coil CNC machined 2-way magnet causing the machine to use less energy, generate less heat and therefore lasts longer
- Reduced risk of damaging machine, tools and workpiece and hurting operator
- Suitable for use in areas and workplaces where power supply is of less quality
- Reduced risk of armature damage
- Reduced risk of control unit(s) damage
- Timely service notification to avoid additional cost by unexpected downtime or unnecessary part replacement

Features



Adjustable speed



R/L rotation



Overload protection



Overheat protection



Power surge protection



Power fluctuation protection



Gyro-Tec



Automatic shut-off



Smart Restart



Oil lubricated gearbox



Digital display



Carbon brush wear indicator



LED load indicators



2-way magnet (TempTec)



Magnet LED-indicator (SensorTec)



Auto feed and return for cutters



Tapping

Optimised motor efficiency and lifetime of key components due to oil lubricated gearbox



ECO.60S+



Watch our machines in action on:
www.youtube.com/euroboorbv



Technical data

Annular cutting	Ø 12 - 60 mm
Twist drilling	Ø 1 - 23 mm
Countersinking	Ø 10 - 65 mm
Length	320 mm
Width	200 mm
Height	452 - 622 mm
Stroke	170 mm
Weight*	12.9 kg
Magnet (l x w x h)	168 x 84 x 49 mm
Magnetic force	1,850 kg
Motor power	1,600 W
Total power	1,700 W
Speed (no load)	I 60 - 275 rpm
	II 100 - 500 rpm
Speed (load 1,600 W)	I 60 - 275 rpm
	II 100 - 500 rpm
Spindle (Weldon)	MT3 19.05 mm (3/4")
Voltage	110 - 120 V / 60 Hz
	220 - 240 V / 50 - 60 Hz

*Exclusive power cord and handles



Benefits

- High-accuracy capstan hub
- Morse Taper 3 spindle with integrated tool cooling and lubrication
- Integrated slide for:
 - High accuracy
 - Enlarged lifecycle
 - Minimal vibration
- High-precision height adjustment for:
 - Low maintenance
 - Minimal wear correction
- Strong dual coil CNC machined 2-way magnet causing the machine to use less energy, generate less heat and therefore lasts longer
- Reduced risk of damaging machine, tools and workpiece and hurting operator
- Suitable for use in areas and workplaces where power supply is of less quality
- Reduced risk of armature damage
- Reduced risk of control unit(s) damage
- Timely service notification to avoid additional cost by unexpected downtime or unnecessary part replacement

Features



Adjustable speed



Overload protection



Overheat protection



Power surge protection



Power fluctuation protection



Gyro-Tec



Automatic shut-off



Smart Restart



Oil lubricated gearbox



Carbon brush wear indicator



2-way magnet (TempTec)



Magnet LED-indicator (SensorTec)

Optimised motor efficiency and lifetime of key components due to oil lubricated gearbox



ECO.80S+



Watch our machines in action on:
www.youtube.com/euroboorbv



Technical data

Annular cutting	Ø 12 - 80 mm
Twist drilling	Ø 1 - 31.75 mm
Countersinking	Ø 10 - 85 mm
Length	365 mm
Width	310 mm
Height	510 - 710 mm
Stroke	260 mm
Weight*	27.3 kg
Magnet (l x w x h)	220 x 110 x 64 mm
Magnetic force	3,000 kg
Motor power	1,700 W
Total power	1,800 W
Speed (no load)	I 200 rpm
	II 300 rpm
	III 415 rpm
	IV 650 rpm
Speed (load 1,700 W)	I 150 rpm
	II 200 rpm
	III 275 rpm
	IV 400 rpm
Spindle (Weldon)	MT3 31.75 mm (1 1/4")
Voltage	110 - 120 V / 60 Hz
	220 - 240 V / 50 - 60 Hz

*Exclusive power cord and handles

Benefits

- Morse Taper 3 spindle with integrated tool cooling and lubrication
- Strong dual coil CNC machined 2-way magnet, causing the machine to use less energy, generate less heat and therefore lasts longer
- Reduced risk of damaging machine, tools and workpiece and hurting operator
- Suitable for use in areas and workplaces where power supply is of less quality
- Reduced risk of armature damage
- Reduced risk of control unit(s) damage
- Timely service notification to avoid additional cost by unexpected downtime or unnecessary part replacement



Features



Overload protection



Overheat protection



Power surge protection



Power fluctuation protection



Gyro-Tec



Automatic shut-off



Smart Restart



Oil lubricated gearbox



Carbon brush wear indicator



2-way magnet (TempTec)



Magnet LED-indicator (SensorTec)

Optimised motor efficiency and lifetime of key components due to oil lubricated gearbox



ECO.100S+/T



Watch our machines in action on:
www.youtube.com/euroboorbv



Technical data

Annular cutting	Ø 12 - 100 mm
Twist drilling	Ø 1 - 31.75 mm
Countersinking	Ø 10 - 105 mm
Tapping	M3 - M30
Length	365 mm
Width	310 mm
Height	510 - 710 mm
Stroke	260 mm
Weight*	27.8 kg
Magnet (l x w x h)	220 x 110 x 64 mm
Magnetic force	3,000 kg
Motor power	1,900 W
Total power	2,050 W
Speed (no load)	I 42 - 110 rpm
	II 65 - 190 rpm
	III 140 - 400 rpm
	IV 220 - 620 rpm
Speed (load 1,900 W)	I 85 rpm
	II 152 rpm
	III 270 rpm
	IV 480 rpm
Spindle (Weldon)	MT3 31.75 mm (1 1/4")
Voltage	110 - 120 V / 60 Hz
	220 - 240 V / 50 - 60 Hz

*Exclusive power cord and handles

Benefits

- Morse Taper 3 spindle with integrated tool cooling and lubrication
- Strong dual coil CNC machined 2-way magnet, causing the machine to use less energy, generate less heat and therefore lasts longer
- Reduced risk of damaging machine, tools and workpiece and hurting operator
- Suitable for use in areas and workplaces where power supply is of less quality
- Reduced risk of armature damage
- Reduced risk of control unit(s) damage
- Timely service notification to avoid additional cost by unexpected downtime or unnecessary part replacement

Features



Adjustable speed



Torque control



R/L rotation



Overload protection



Overheat protection



Power surge protection



Power fluctuation protection



Gyro-Tec



Automatic shut-off



Smart Restart



Oil lubricated gearbox



Carbon brush wear indicator



2-way magnet (TempTec)



Magnet LED-indicator (SensorTec)



Tapping

Optimised motor efficiency and lifetime of key components due to oil lubricated gearbox



ECO.100S+/TD



Watch our machines in action on:
www.youtube.com/euroboorbv



Technical data

Annular cutting	Ø 12 - 100 mm
Twist drilling	Ø 1 - 31.75 mm
Countersinking	Ø 10 - 105 mm
Tapping	M3 - M30
Length	365 mm
Width	310 mm
Height	515 - 715 mm
Stroke	260 mm
Weight*	31 kg
Magnet (l x w x h)	220 x 110 x 64 mm
Magnetic force	3,000 kg
Motor power	1,900 W
Total power	2,050 W
Speed (no load)	I 42 - 110 rpm
	II 65 - 190 rpm
	III 140 - 400 rpm
	IV 220 - 620 rpm
Speed (load 1,900 W)	I 85 rpm
	II 152 rpm
	III 270 rpm
	IV 480 rpm
Spindle (Weldon)	MT3 31.75 mm (1 1/4")
Voltage	110 - 120 V / 60 Hz
	220 - 240 V / 50 - 60 Hz

*Exclusive power cord and handles

Benefits

- Precise positioning swivel base, rotate the machine 30° both ways and slide 15-20 mm forward and backwards
- Morse Taper 3 spindle with integrated tool cooling and lubrication
- Strong dual coil CNC machined 2-way magnet, causing the machine to use less energy, generate less heat and therefore lasts longer
- Reduced risk of damaging machine, tools and workpiece and hurting operator
- Suitable for use in areas and workplaces where power supply is of less quality
- Reduced risk of armature damage
- Reduced risk of control unit(s) damage
- Timely service notification to avoid additional cost by unexpected downtime or unnecessary part replacement

Features



Adjustable speed



Torque control



R/L rotation



Overload protection



Overheat protection



Power surge protection



Power fluctuation protection



Gyro-Tec



Automatic shut-off



Smart Restart



Oil lubricated gearbox



Carbon brush wear indicator



2-way magnet (TempTec)



Magnet LED-indicator (SensorTec)



Swivelbase magnet



Tapping



Optimised motor efficiency and lifetime of key components due to oil lubricated gearbox



ECO.100S+/CT



Watch our machines in action on:
www.youtube.com/euroboorbv



Technical data

Annular cutting	Ø 12 - 100 mm
Twist drilling	Ø 1 - 31.75 mm
Countersinking	Ø 10 - 105 mm
Tapping	M3 - M30
Milling	Ø 14 mm
Length	497 mm
Width	375 mm
Height	615 - 793 mm
Stroke	260 mm
Travel distance	X-axis 110 mm
	Y-axis 120 mm
Weight*	55 kg
Magnet (l x w x h)	220 x 220 x 64 mm
Magnetic force	4,300 kg
Motor power	1,900 W
Total power	2,200 W
Speed (no load)	I 42 - 110 rpm
	II 65 - 190 rpm
	III 140 - 400 rpm
	IV 220 - 620 rpm
Speed (load 1,900 W)	I 42 rpm
	II 65 rpm
	III 140 rpm
	IV 220 rpm
Spindle (Weldon)	MT3 31.75 mm (1 1/4")
Voltage	110 - 120 V / 60 Hz
	220 - 240 V / 50 - 60 Hz



Benefits

- Cross Table base to give dynamic positioning during drilling procedure over a range of 110 mm (x-axis) and 120 mm (y-axis)
- Milling feature to create slots and work on complex workpieces
- Switch to Tapping to create perfectly centered threads, while machine stays fixed on workpiece
- Strong dual coil CNC machined 2-way magnet, causing the machine to use less energy, generate less heat and therefore lasts longer
- Advanced safety features to reduce the risks of damaging the machine, tools, workpiece, armature, control unit(s) or hurting the operator
- Morse Taper 3 spindle with integrated tool cooling and lubrication
- Suitable for use in areas and workplaces where power supply is of less quality
- Timely service notification to avoid additional costs of unexpected downtime or unnecessary part replacement

Features



Adjustable speed



Torque control



R/L rotation



Overload protection



Overheat protection



Power surge protection



Power fluctuation protection



Gyro-Tec



Automatic shut-off



Smart Restart



Oil lubricated gearbox



Carbon brush wear indicator



2-way magnet (TempTec)



Magnet LED-indicator (SensorTec)



Cross table



Milling



Tapping

Optimised motor efficiency and lifetime of key components due to oil lubricated gearbox



ECO.200S/T



Watch our machines in action on:
www.youtube.com/euroboorbv



Technical data

Annular cutting	Ø 12 - 200 mm
Twist drilling	Ø 1 - 50 mm
Countersinking	Ø 10 - 205 mm
Tapping	M3 - M48
Length	515 mm
Width	265 mm
Height	650 - 905 mm
Stroke	255 mm
Weight*	58.5 kg
Magnet (l x w x h)	350 x 125 x 66 mm
Magnetic force	3,680 kg
Motor power	2,600 W
Total power	2,750 W
Speed (no load)	I 40 - 80 rpm
	II 60 - 125 rpm
	III 145 - 300 rpm
	IV 230 - 470 rpm
Speed (load 2600 W)	I 29 - 75 rpm
	II 46 - 120 rpm
	III 110 - 285 rpm
	IV 174 - 452 rpm
Spindle (Weldon)	MT4 31.75 mm (1 1/4")
Voltage	220 - 240 V / 50 - 60 Hz

*Exclusive power cord and handles



Benefits

- Four-speed gearbox
- Integrated tool cooling and lubrication tank and fluid level indication
- Integrated safety strap and lifting shackle
- Progressive feed assist
- Morse Taper 4 spindle
- Strong triple coil CNC machined magnet
- Brushless technology

Features



Adjustable speed



R/L rotation



Overload protection



Overheat protection



Power surge protection



Power fluctuation protection



Gyro-Tec



Integrated motor cable



Brushless motor



Oil lubricated gearbox



Magnet LED-Indicator (SensorTec)



Tapping

Optimised motor efficiency and lifetime of key components due to oil lubricated gearbox





Unique design, unique usage

Drilling high-precision holes in steel tubes and pipes has always been a hassle. Until now! "Position and use" is what you expect of a portable power tool. Forget about the time consuming process of clamping all kinds of pipe adapters to your work piece.

Meet our TUBE-serie, an innovative generation drilling machines specifically designed for drilling on curved material. By joining forces with Magswitch, technology leader in switchable magnetic technology, we have been able to develop a concept that instantly addresses, and

drastically improves work efficiency in the pipe industry. Not only will these help you save time. Its strong, powerful and sturdy design will also actively enable you to drill holes as fast as possible.

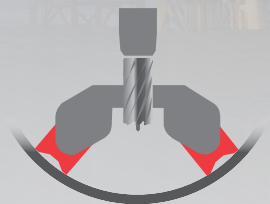
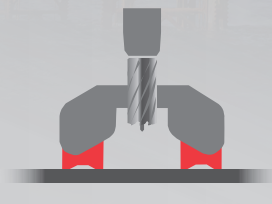

The magnets can be adjusted for the best position on round and flat surfaces. No extra accessories needed

Safe

Magnets do not require electrical power.

Light

The machines are extremely light.
TUBE.30 - 10.3 kg
TUBE.30s+ - 11 kg
TUBE.55S/T - 17.6 kg
TUBE.55s+/T - 17.6 kg
TUBE.55/AIR - 16.7 kg

Strong

Maintains strong grip on thin steel. Minimal thickness of 3 mm.

Easy to use

Automatically conform to any pipe Ø 76.2 mm or larger in diameter.

Efficient

One tool for flat or round surfaces without the need for expensive adapters – save time and money.

TUBE.30



Watch our machines in action on:
www.youtube.com/euroboorbv



Technical data

Annular cutting	Ø 12 - 30 mm
Twist drilling (Weldon)	Ø 1 - 13 mm
Countersinking (Weldon)	Ø 10 - 35 mm
Length	275 mm
Width	185 mm
Height	326 - 416 mm
Stroke	90 mm
Weight*	10.3 kg
Magnet (l x w x h)	187 x 165 x 83 mm
Magnetic force	532 kg
Min. material thickness	3 mm
Min. pipe diameter	76.2 mm (3")
Motor power	900 W
Total power	950 W
Speed (no load)	I 775 rpm
Speed (load 900 W)	I 400 rpm
Spindle (Weldon)	19.05 mm (3/4")
Voltage	110 - 120 V / 60 Hz
	220 - 240 V / 50 - 60 Hz

*Exclusive power cord and handles

Benefits

- The magnets can be adjusted for the best position on round and flat surfaces
- High-accuracy capstan hub
- Direct spindle drive and integrated tool cooling and lubrication
- One-speed gearbox
- Integrated slide for:
 - High accuracy
 - Enlarged lifecycle
 - Minimal vibration
- High-precision height adjustment for:
 - Low maintenance
 - Minimal wear correction
- Reversible handles: to enable you to change the operation side of the feed handles in confined spaces
- Also available with electromagnetic magnet (page. 12)

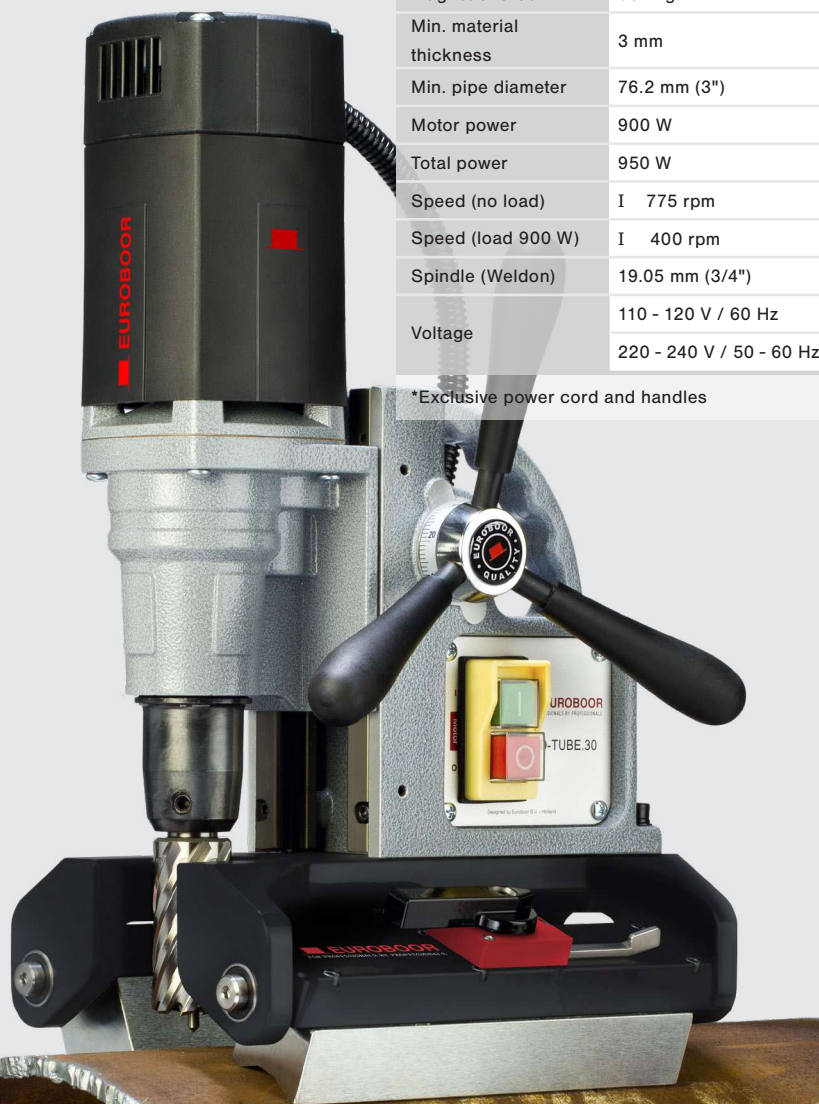

Features



Permanent magnet)

TUBE.30S+



Watch our machines in action on:
www.youtube.com/euroboorbv

Technical data

Annular cutting	Ø 12 - 30 mm
Twist drilling (Weldon)	Ø 1 - 13 mm
Countersinking (Weldon)	Ø 10 - 35 mm
Length	275 mm
Width	185 mm
Height	326 - 416 mm
Stroke	90 mm
Weight*	11 kg
Magnet (l x w x h)	187 x 165 x 83 mm
Magnetic force	532 kg
Min. material thickness	3 mm
Min. pipe diameter	76.2 mm (3")
Motor power	900 W
Total power	950 W
Speed (no load)	I 775 rpm
Speed (load 900 W)	I 400 rpm
Spindle (Weldon)	19.05 mm (3/4")
Voltage	110 - 120 V / 60 Hz
	220 - 240 V / 50 - 60 Hz

*Exclusive power cord and handles

Benefits

- The magnets can be adjusted for the best position on round and flat surfaces
- High-accuracy capstan hub
- Direct spindle drive and integrated tool cooling and lubrication
- Integrated slide for:
 - High accuracy
 - Enlarged lifecycle
 - Minimal vibration
- High-precision height adjustment for:
 - Low maintenance
 - Minimal wear correction
- Reversible handles: to enable you to change the operation side of the feed handles in confined spaces
- Reduced risk of damaging machine, tools and workpiece and hurting operator
- Suitable for use in areas and workplaces where power supply is of less quality
- Reduced risk of armature damage
- Reduced risk of control unit(s) damage
- Timely service notification to avoid additional cost by unexpected downtime or unnecessary part replacement
- Also available with electromagnetic magnet (page. 13)

Features



Power surge protection



Power fluctuation protection



Gyro-Tec



Automatic shut-off



Oil lubricated gearbox



Carbon brush wear indicator



Permanent magnet

Optimised motor efficiency and lifetime of key components due to oil lubricated gearbox

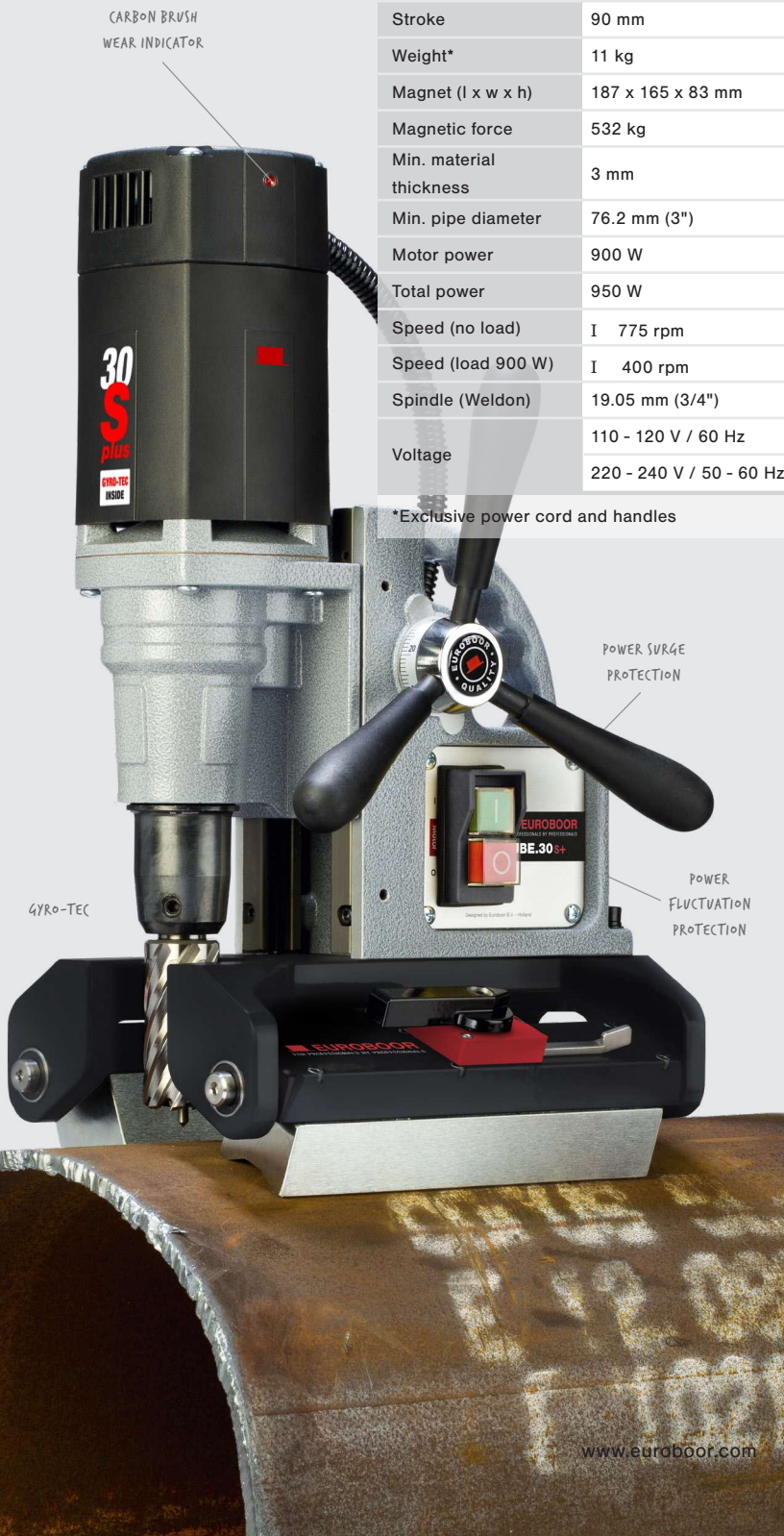

TUBE.55S+/T



Watch our machines in action on:
www.youtube.com/euroboorbv



Technical data

Annular cutting	Ø 12 - 55 mm
Twist drilling	Ø 1 - 23 mm
Countersinking	Ø 10 - 60 mm
Tapping	M3 - M20
Length	320 mm
Width	210 mm
Height	523 - 693 mm
Stroke	170 mm
Weight*	16 kg
Magnet (l x w x h)	275 x 190 x 90 mm
Magnetic force	900 kg
Min. material thickness	3 mm
Min. pipe diameter	80 mm
Motor power	1,600 W
Total power	1,700 W
Speed (no load)	I 60 - 275 rpm
	II 100 - 500 rpm
Speed (load 1,600 W)	I 60 - 275 rpm
	II 100 - 500 rpm
Spindle (Weldon)	MT3 19.05 mm (3/4")
Voltage	110 - 120 V / 60 Hz
	220 - 240 V / 50 - 60 Hz

*Exclusive power cord and handles

Benefits

- The magnets can be adjusted for the best position on round and flat surfaces
- Easily accessible carbon brushes. Motor will automatically shut-off in case of replacement
- High-accuracy capstan hub
- Morse Taper 3 spindle with integrated tool cooling and lubrication
- Integrated slide for:
 - High accuracy
 - Enlarged lifecycle
 - Minimal vibration
- High-precision height adjustment for:
 - Low maintenance
 - Minimal wear correction
- Reduced risk of damaging machine, tools and workpiece and hurting operator
- Suitable for use in areas and workplaces where power supply is of less quality
- Reduced risk of armature damage
- Reduced risk of control unit(s) damage
- Timely service notification to avoid additional cost by unexpected downtime or unnecessary part replacement
- Also available with electromagnetic magnet (page. 28)

Features



Adjustable speed



R/L rotation



Overload protection



Overheat protection



Power surge protection



Power fluctuation protection



Gyro-Tec



Automatic shut-off



Oil lubricated gearbox



Digital display



Carbon brush wear indicator



LED load indicators



Permanent magnet



Tapping

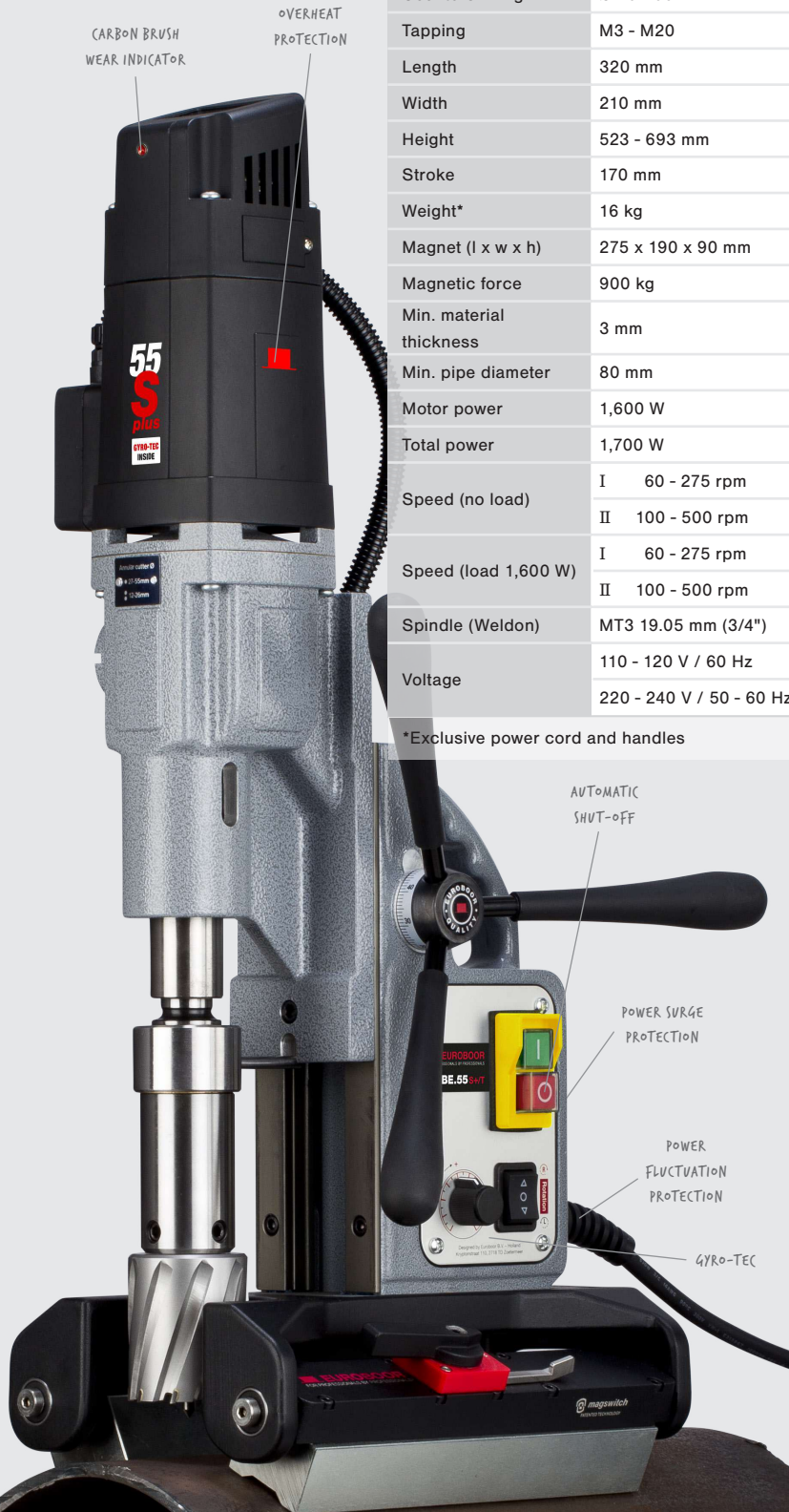

Optimised motor efficiency and lifetime of key components due to oil lubricated gearbox



TUBE.55/AIR



Watch our machines in action on:
www.youtube.com/euroboorbv



Technical data

Annular cutting	Ø 12 - 52 mm (HSS) Ø 12 - 55 mm (TCT)
Twist drilling	Ø 1 - 23 mm
Countersinking	Ø 10 - 55 mm
Length	345 mm
Width	245 mm
Height	630 - 730 mm
Stroke	167 mm
Weight*	16.7 kg
Magnet (l x w x h)	275 x 190 x 90 mm
Magnetic force	900 kg
Min. material thickness	3 mm
Min. pipe diameter	80 mm
Speed (no load)	380 rpm
Spindle (Weldon)	MT3 19.05 mm (3/4")
Power source	Air, min. 6.3 bar, max. 8 bar, consumption 1.1 m ³ /min

* Exclusive handles



Benefits

- Air-powered motor system
- The magnets can be adjusted for the best position on round and flat surfaces
- Powerful, spark-free, explosion-safe motor
- Large 167 mm stroke
- Automatic, integrated lubrication and cooling system
- Anti-static construction
- Also available with permanent base magnet (page. 53)

Magnet benefits

- Permanent, non-electric magnet system
- No loss of magnetic grip in case of electric power cuts or fluctuations
- Flexible dual magnet array which automatically adjust to the geometry of the workpiece
- Powerful hold, even on thinner steel thicknesses

Features



Permanent magnet



Air motor:
min 6.3 bar
(90 PSI)



Atex

AIR.55



Watch our machines in action on:
www.youtube.com/euroboorbv



Technical data

Annular cutting	Ø 12 - 52 mm (HSS) Ø 12 - 55 mm (TCT)
Twist drilling	Ø 1 - 23 mm
Countersinking	Ø 10 - 55 mm
Length	380 mm
Width	245 mm
Height	615 - 705 mm
Stroke	167 mm
Weight*	16.5 kg
Magnet (l x w x h)	183 x 100 x 55 mm
Magnetic force	900 kg
Speed (no load)	380 rpm
Spindle (Weldon)	MT3 19.05 mm (3/4")
Power source	Air, min. 6.3 bar, max. 8 bar, consumption 1.1 m ³ /min

*Exclusive handles



Benefits

- Air-powered motor system
- Powerful, spark-free, explosion-safe motor
- Single operation knob for magnet and motor with 'deadman's' control
- Large 167 mm stroke
- Automatic, integrated lubrication and cooling system
- Anti-static construction
- Safety guard
- Also available with permanent tube magnet for both pipe and flat material (page. 48)

Magnet benefits

- Permanent, non-electric monobloc magnet system
- No loss of magnetic grip in case of electric power cuts or fluctuations
- Powerful hold, even on thinner steel thicknesses

Features



Permanent magnet



Air motor:
min 6.3 bar
(90 PSI)



Atex

ECO.36



Watch our machines in action on:
www.youtube.com/euroboorbv



Technical data

Annular cutting	Ø 12 - 36 mm
Twist drilling (Weldon)	Ø 1 - 14 mm
Countersinking (Weldon)	Ø 10 - 40 mm
In-corner drilling	0° 50 mm centre to edge
	90° 53 mm centre to edge
	45° 60 mm centre to edge
Length	310 mm
Width	135 mm
Height	165 mm
Stroke	40 mm
Weight*	10.3 kg
Magnet (l x w x h)	160 x 80 x 37 mm
Magnetic force	1,200 kg
Motor power	1,050 W
Total power	1,100 W
Speed (no load)	I 700 rpm
Speed (load 1,050 W)	I 400 rpm
Spindle (Weldon)	19.05 mm (3/4")
Voltage	110 - 120 V / 60 Hz
	220 - 240 V / 50 - 60 Hz

*Exclusive power cord and handle

Benefits

- One-speed gearbox
- User friendly Quick-Connect cutter fitment system
- Integrated carrying handle and safety strap attachment
- Left and right mount ability of detachable ratchet feed handle
- Integrated tool cooling and lubrication
- Removable and slideable safety guard
- Lubrication bottle with magnet attachment
- Strong dual coil CNC machined 2-way magnet causing the machine to use less energy, generate less heat and therefore lasts longer

Lowest machine
in the market



Features



Integrated motor cable



2-way magnet (TempTec)



In-corner: 50 mm



Height: 165 mm

ECO.36+



Watch our machines in action on:
www.youtube.com/euroboorbv



Technical data

Annular cutting	Ø 12 - 36 mm
Twist drilling (Weldon)	Ø 1 - 14 mm
Countersinking (Weldon)	Ø 10 - 40 mm
In-corner drilling	0° 50 mm centre to edge
	90° 53 mm centre to edge
	45° 60 mm centre to edge
Length	310 mm
Width	135 mm
Height	165 mm
Stroke	40 mm
Weight*	10.3 kg
Magnet (l x w x h)	160 x 80 x 37 mm
Magnetic force	1,200 kg
Motor power	1,050 W
Total power	1,100 W
Speed (no load)	I 700 rpm
Speed (load 1,050 W)	I 400 rpm
Spindle (Weldon)	19.05 mm (3/4")
Voltage	110 - 120 V / 60 Hz
	220 - 240 V / 50 - 60 Hz

*Exclusive power cord and handle

Benefits

- One-speed gearbox
- User friendly Quick-Connect cutter fitment system
- Integrated carrying handle and safety strap attachment
- Left and right mount ability of detachable ratchet feed handle
- Integrated tool cooling and lubrication
- Removable and slideable safety guard
- Lubrication bottle with magnet attachment
- Strong dual coil CNC machined 2-way magnet, causing the machine to use less energy, generate less heat and therefore lasts longer
- Reduced risk of damaging machine, tools and workpiece and hurting operator
- Suitable for use in areas and workplaces where power supply is of less quality
- Reduced risk of armature damage
- Reduced risk of control unit(s) damage
- Timely service notification to avoid additional cost by unexpected downtime or unnecessary part replacement



Features



Power surge protection



Power fluctuation protection



Gyro-Tec



Integrated motor cable



Automatic shut-off



Carbon brush wear indicator



2-way magnet (TempTec)



In-corner: 50 mm



Height: 165 mm

ECO.36+T



Watch our machines in action on:
www.youtube.com/euroboorbv



Technical data

Annular cutting	Ø 12 - 36 mm
Twist drilling (Weldon)	Ø 1 - 14 mm
Countersinking (Weldon)	Ø 10 - 40 mm
Tapping	M3 - M12
In-corner drilling	0° 50 mm centre to edge
	90° 53 mm centre to edge
	45° 60 mm centre to edge
Length	310 mm
Width	135 mm
Height	165 mm
Stroke	40 mm
Weight*	10.3 kg
Magnet (l x w x h)	160 x 80 x 37 mm
Magnetic force	1,200 kg
Motor power	1,050 W
Total power	1,100 W
Speed (no load)	I 120 - 500 rpm
Speed (load 1,050 W)	I 120 - 400 rpm
Spindle (Weldon)	19.05 mm (3/4")
Voltage	110 - 120 V / 60 Hz
	220 - 240 V / 50 - 60 Hz

*Exclusive power cord and handle

Benefits

- One-speed gearbox
- User friendly Quick-Connect cutter fitment system
- Integrated carrying handle and safety strap attachment
- Integrated tool cooling and lubrication
- Removable and slideable safety guard
- Lubrication bottle with magnet attachment
- Strong dual coil CNC machined 2-way magnet, causing the machine to use less energy, generate less heat and therefore lasts longer
- Reduced risk of damaging machine, tools and workpiece and hurting operator
- Suitable for use in areas and workplaces where power supply is of less quality
- Reduced risk of armature damage
- Reduced risk of control unit(s) damage
- Timely service notification to avoid additional cost by unexpected downtime or unnecessary part replacement



CARBON BRUSH WEAR INDICATOR
INTEGRATED MOTOR CABLE
AUTOMATIC SHUT-OFF

GYRO-TEC

TEMPTEC

POWER SURGE PROTECTION

POWER FLUCTUATION PROTECTION

Features



Adjustable speed



R/L rotation



Overload protection



Overheat protection



Power surge protection



Power fluctuation protection



Gyro-Tec



Integrated motor cable



Automatic shut-off



Carbon brush wear indicator



2-way magnet (TempTec)



Tapping



In-corner: 50 mm



Height: 165 mm

EBM.36+LP/P-18V Battery Operated



Watch our machines in action on:
www.youtube.com/euroboorbv



Technical data

Annular cutting	Ø 12 - 36 mm
Twist drilling	Ø 1 - 13 mm
Countersinking	Ø 10 - 40 mm
Length	340 mm
Width	140 mm
Height	174 mm
Stroke	40 mm
Weight (incl. batt)*	11.3 kg
Magnet (l x w x h)	176 x 85 x 45 mm
Magnetic force	650 kg
Min. material thickness	6 mm
Motor power	1,000 W
Total power	1,000 W
Speed (no load)	270 - 430 rpm
Speed (load)	270 - 430 rpm
Spindle (Weldon)	19.05 mm
Battery capacity	18 V 5 Ah Li-ion, 18 V 9 Ah Li-ion

*Exclusive handles

Benefits

- Battery-powered motor system
- User friendly Quick-Connect cutter fitment system
- Integrated carrying handle and safety strap attachment
- Left and right mount ability of detachable feed handle
- Compact and lightweight design
- Based on Makita LXT 18V battery platform
- Integrated tool cooling and lubrication
- Removable and slideable safety guard
- Lubrication bottle with magnet attachment
- Brushless technology

Magnet benefits

- Permanent, non-electric monobloc magnet system
- No loss of magnetic grip in case of electric power cuts or fluctuations
- Powerful hold, even on thinner steel

Features



Adjustable speed



Overload protection



Overheat protection



Gyro-Tec



Integrated motor cable



Permanent magnet



Brushless motor



Magnet LED-indicator (SensorTec)



Battery operated



Makita LXT 18V platform

Accessories



Batteries 5Ah and 9Ah

EB5A, EB9A



Charger

EBC1



EBM.36+ / P-18V Battery Operated



Watch our machines in action on:
www.youtube.com/euroboorbv



Technical data

Annular cutting	Ø 12 - 36 mm
Twist drilling	Ø 1 - 13 mm
Countersinking	Ø 10 - 40 mm
Length	325 mm
Width	235 mm
Height	370 - 410 mm
Stroke	140 mm
Weight (incl. batt)*	10.2 kg
Magnet (l x w x h)	157 x 85 x 45 mm
Magnetic force	650 kg
Min. material thickness	6 mm
Motor power	1,000 W
Total power	1,000 W
Speed (no load)	530 rpm
Speed (load)	430 rpm
Spindle (Weldon)	19.05 mm
Battery capacity	18 V 5 Ah Li-ion, 18 V 9 Ah Li-ion

*Exclusive handles



Benefits

- Battery-powered motor system
- Integrated carrying handle and safety strap attachment
- Left and right mount ability of detachable feed handle
- Compact and lightweight design
- Based on Makita LXT 18V battery platform
- Integrated tool cooling and lubrication
- Brushless technology

Magnet benefits

- Permanent, non-electric monobloc magnet system
- No loss of magnetic grip in case of electric power cuts or fluctuations
- Powerful hold, even on thinner steel

Features



Gyro-Tec



Overload protection



Overheat protection



Integrated motor cable



Permanent magnet



Brushless motor



Magnet LED-indicator (SensorTec)



Battery operated



Makita LXT 18V platform

Accessories



Batteries 5Ah and 9Ah
EB5A, EB9A



Charger
EBC1

SAFETY FIRST



EBM.360 Battery Operated



Watch our machines in action on:
www.youtube.com/euroboorbv



Technical data

Annular cutting	Ø 12 - 36 mm
Twist drilling	Ø 1 - 13 mm
Countersinking	Ø 10 - 40 mm
Length	297 mm
Width	112 mm
Height	420 - 610 mm
Stroke	230 mm
Weight*	11.7 kg
Magnet (l x w x h)	160 x 80 x 42 mm
Magnetic force	1,700 kg
Motor power	1,300 W DC
Total power	1,350 W DC
Speed (no load)	I 506 rpm
Speed (load 1,300 W)	I 375 rpm
Spindle (Weldon)	19.05 mm (3/4")
Power source	37 V Battery 2.6 Ah li-ion

*Exclusive handles



Benefits

- Powerful battery with charger
- Powerful high-torque DC motor
- Multi-level electronic protection for optimal safety
- Extremely short battery charging time
- Detachable spindle and integrated tool cooling and lubrication
- High-precision height adjustment for:
 - Low maintenance
 - Minimal wear correction
- Strong dual coil CNC machined magnet

Features



Overload
protection



Overheat
protection



Battery
operated

Accessories



Battery & charger

Art. nr.: 360.0503



INNOVATION IS HERE

VAC.50S+

IT SUCKS!

VAC.50s+



Watch our machines in action on:
www.youtube.com/euroboorbv



Technical data

Annular cutting	
- steel and hard metals	Ø 12 - 30 mm
- other metals and plastic	Ø 12 - 50 mm
Twist drilling	
- steel and hard metals	Ø 1 - 13 mm
- other metals and plastic	Ø 1 - 23 mm
Countersinking	Ø 10 - 55 mm
Length	430 mm
Width	190 mm
Height	420 - 590 mm
Stroke	170 mm
Weight*	9.9 kg
Vac-base (l x w x h)	300 x 140 x 21 mm
Adsorption force	300 kg
Vacuum motor (integrated)	
- Air flow	15 L/min
- Gauge pressure	-80 kPa
- Power	12 W
- Voltage	12 V
Motor power	1,250 W
Total power	1,300 W
Speed (no load)	I 380 rpm
	II 690 rpm
Speed (load 1,250 W)	I 235 rpm
	II 415 rpm
Spindle (Weldon)	MT3 19.05 mm (3/4")
Voltage	110 - 120 V / 60 Hz
	220 - 240 V / 50 - 60 Hz

*Exclusive power cord and handles

Benefits

- High-accuracy capstan hub
- Morse Taper 3 spindle with integrated tool cooling and lubrication
- Integrated slide for:
 - High accuracy
 - Enlarged lifecycle
 - Minimal vibration
- High-precision height adjustment for:
 - Low maintenance
 - Minimal wear correction
- Vacuum technology for almost all (magnetic and non-magnetic) smooth surfaces
- Reduced risk of damaging machine, tools and workpiece and hurting operator
- Suitable for use in areas and workplaces where power supply is of less quality
- Reduced risk of armature damage
- Reduced risk of control unit(s) damage
- Timely service notification to avoid additional cost by unexpected downtime or unnecessary part replacement

Features



Overload protection



Overheat protection



Power surge protection



Power fluctuation protection



Vacu-Tec



Integrated motor cable



Automatic shut-off



Oil lubricated gearbox



Carbon brush wear indicator



VAC
Vacuum LED-indicator



Optimised motor efficiency and lifetime of key components due to oil lubricated gearbox



RAIL.40S



Watch our machines in action on:
www.youtube.com/euroboorbv



Technical data

Annular cutting	Ø 12 - 36 mm
Length	230 mm
Width	180 mm
Height	495 - 610 mm
Stroke	155 mm
Weight*	12 kg
Motor power	1,150 W
Total power	1,200 W
Speed (no load)	I 600 rpm
Speed (load 1,150 W)	I 380 rpm
Spindle (Weldon)	19.05 mm (3/4")
Voltage	110 - 120 V / 60 Hz
	220 - 240 V / 50 - 60 Hz

*Exclusive power cord and handles

Benefits

- Suitable for processing rails
- High-efficiency motor with less heat generation
- High-accuracy capstan hub
- Direct spindle drive
- Integrated slide for:
 - High accuracy
 - Enlarged lifecycle
 - Minimal vibration
- High-precision height adjustment for:
 - Low maintenance
 - Minimal wear correction



Including 6 different rail adapter versions:
 S49, S54, TRC68, UIC50, UIC54 and UIC60.

Features



Oil lubricated
gearbox

Optimised motor efficiency and lifetime of
key components due to oil lubricated gearbox



RAIL.360 Battery Operated



Watch our machines in action on:
www.youtube.com/euroboorbv



Technical data

Annular cutting	Ø 12 - 36 mm
Twist drilling	Ø 1 - 13 mm
Countersinking	Ø 10 - 40 mm
Length	297 mm
Width	112 mm
Height	420 - 610 mm
Stroke	230 mm
Weight*	11.7 kg
Magnet (l x w x h)	160 x 80 x 42 mm
Motor power	1,300 W DC
Total power	1,350 W DC
Speed (no load)	I 506 rpm
Speed (load 1,300 W)	I 375 rpm
Spindle (Weldon)	19.05 mm (3/4")
Power source	37 V Battery 2.6 Ah li-ion

*Exclusive handles

Benefits

- Powerful battery with charger
- Powerful high-torque DC motor
- Multi-level electronic protection for optimal safety
- Extremely short battery charging time
- Detachable spindle and integrated tool cooling and lubrication
- High-precision height adjustment for:
 - Low maintenance
 - Minimal wear correction



Features



Overload protection



Overheat protection



Battery operated

Accessories



Battery & charger

Art. nr.: 360.0503



Including 6 different rail adapter versions:
S49, S54, TRC68, UIC50, UIC54 and UIC60.

F16



Watch our machines in action on:
www.youtube.com/euroboorbv



Technical data

Twist drilling	Ø 1 - 16 mm*
Length	310 mm
Width	170 mm
Height	325 - 495 mm
Stroke	170 mm
Weight**	7.5 kg
Magnet (l x w x h)	160 x 80 x 36 mm
Magnetic force	1,200 kg
Voltage	110 - 120 V / 60 Hz
	220 - 240 V / 50 - 60 Hz

*Hand drill dependable

**Exclusive power cord and handles

Benefits

- Perfect solution for high-precision small diameter drilling tasks
- 43 mm Euro collar connection (33 mm and 38 mm filler rings included)
- Safe and easy rear mounted socket
- High-accuracy capstan hub
- High-precision height adjustment for:
 - Low maintenance
 - Minimal wear correction
- Strong dual coil CNC machined magnet
- Reversible handles: to enable you to change the operation side of the feed handles in confined spaces

Suitable for your
favorite hand drilling
machine



Mounted hand drilling machine not included.

Features



2-way
magnet
(TempTec)



Magnet
LED-indicator
(SensorTec)

F16+



Watch our machines in action on:
www.youtube.com/euroboorbv



Technical data

Twist drilling	Ø 1 - 16 mm*
Length	310 mm
Width	170 mm
Height	325 - 495 mm
Stroke	170 mm
Weight**	7.5 kg
Magnet (l x w x h)	160 x 80 x 36 mm
Magnetic force	1,200 kg
Voltage	110 - 120 V / 60 Hz
	220 - 240 V / 50 - 60 Hz

*Hand drill dependable

**Exclusive power cord and handles

Benefits

- Perfect solution for high-precision small diameter drilling tasks
- 43 mm Euro collar connection (33 mm and 38 mm filler rings included)
- Safe and easy rear mounted socket
- High-accuracy capstan hub
- High-precision height adjustment for:
 - Low maintenance
 - Minimal wear correction
- Strong dual coil CNC machined 2-way magnet causing the machine to use less energy, generate less heat and therefore lasts longer
- Reversible handles: to enable you to change the operation side of the feed handles in confined spaces
- Reduced risk of damaging machine, tools and workpiece and hurting operator
- Suitable for use in areas and workplaces where power supply is of less quality
- Reduced risk of armature damage
- Reduced risk of control unit(s) damage
- No unexpected downtime or unnecessary part replacement



Mounted hand drilling machine not included.

Features



Power surge protection



Power fluctuation protection



Gyro-Tec



2-way magnet (TempTec)



Magnet LED-indicator (SensorTec)

EBH.750/18V Battery Operated



Watch our machines in action on:
www.youtube.com/euroboorbv



Technical data

Length	210 mm
Width	75 mm
Height	200 mm
Weight	1.38 Kg
Max Torque low gear	75 Nm
Max Torque high gear	50 Nm
Speed (no load) gear 1	0 - 500 rpm
Speed (no load) gear 2	0 - 2,000 rpm
Gearbox	2-Speed mechanical
Connection	1.5 mm - 13.0 mm Quick Connect
Battery capacity	18 V 5 Ah Li-ion, 18 V 9 Ah Li-ion

Benefits

- Cordless and highly portable
- Soft grip handle
- Built-in LED work light
- Based on Makita LXT 18V battery platform
- 21-stage slip clutch and adjustable speed control
- Brushless technology



Features

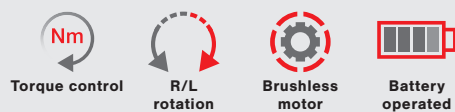

Makita
LXT 18V
platform

Accessories



Batteries 5Ah and 9Ah

Charger

EB5A, EB9A

EBC1

Battery not included.

PST.2500/3 Powerstation



Watch our machines in action on:
www.youtube.com/euroboorbv



Technical data

Output voltage	AC 220 V 50/60 Hz
Socket specification	3 x EU type F (grounded) IP44
Rated output power	Max. 3,500 W
Surge power Max.	Max. 7,000 W
Overload protection	Fuse (20 A)
Battery capacity	2.496 Wh
Battery type	Ternary Lithium Ion battery cell
Battery voltage	DC 48 V
Battery cooling	Air (2 x automatic air fans)
Charger voltage	AC 200-240 V 50/60 Hz
Charger output	54.6 V (15 A)
Charging time	± 3.0 hours
Charging cycles	1,500 x (capacity > 80%)
Operating temperature	-20°C up to 40°C
Charging temperature	0°C up to 30°C
Storage temperature	0°C up to 25°C
Dimensions (L x W x H)	550 x 310 x 460 mm
Weight	28.3 kg
Ingress protection class	IP21S (indoor)

Features

- Continuous load of 3,500 W
- Peak load of 7,000 W
- High Capacity Ternary Lithium Ion Cells
- Fast rechargeable (3 hours)
- 3 power outlets 220 V
- Electricity supply without fluctuations
- Can be used practically everywhere
- Easy to use
- Ideal for heavy duty industrial power tools
- No noise, no smell, no pollution



100%
CHARGED
3
HOURS

